



Dental-Instruments Germany



Neuheiten & Topseller 2024 / 2025

**NEW!**

Ref. 13-88R

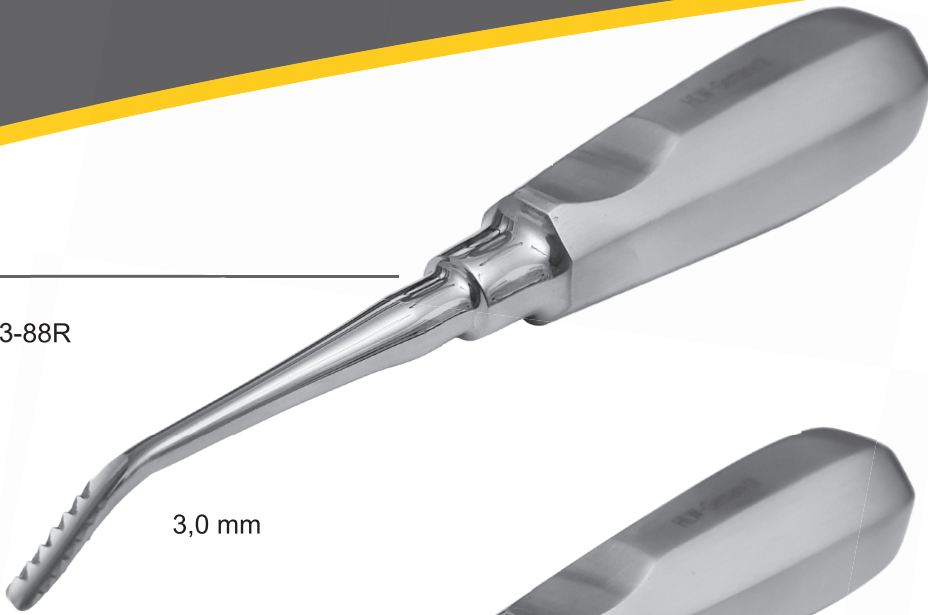

3,0 mm

Ref. 13-88L



3,0 mm

Ref. 13-85



3,0 mm

Ref. 13-85C

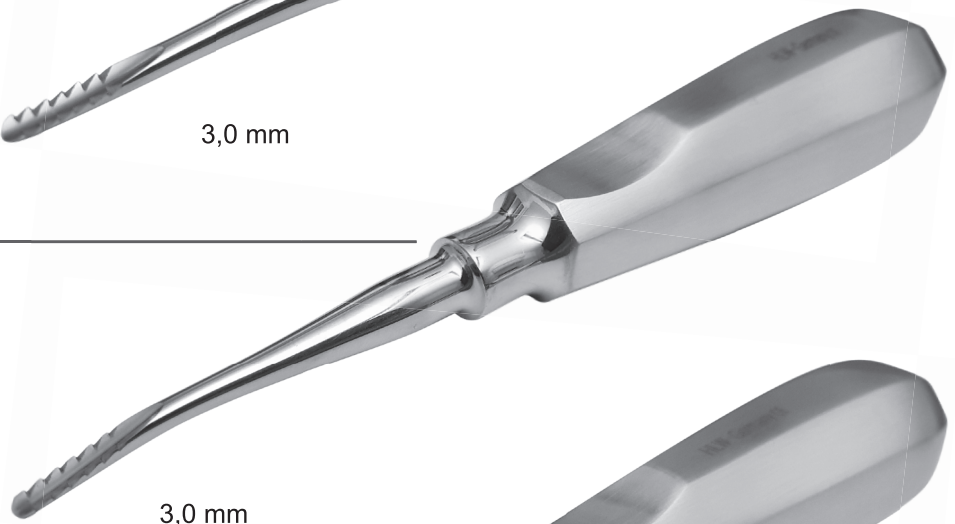

3,0 mm

Ref. 13-89D



distal

3,0 mm



Die Widerhaken erleichtern die Wurzelextraktion und ersetzen die Hebelwirkung.

**NEW!**

Bestell-Nr.  
Order-No.



Ref. 13-86

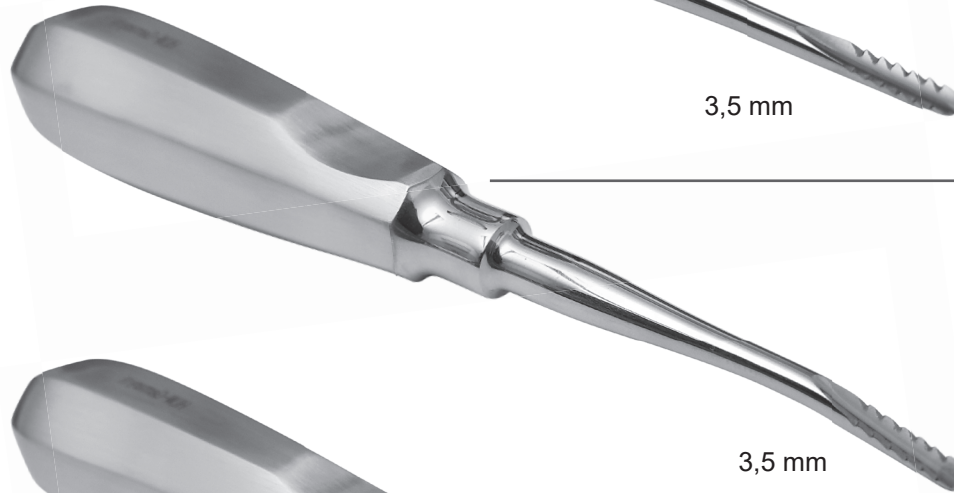

3,5 mm

Ref. 13-86C



3,5 mm

Ref. 13-87



4,0 mm

Ref. 13-87C

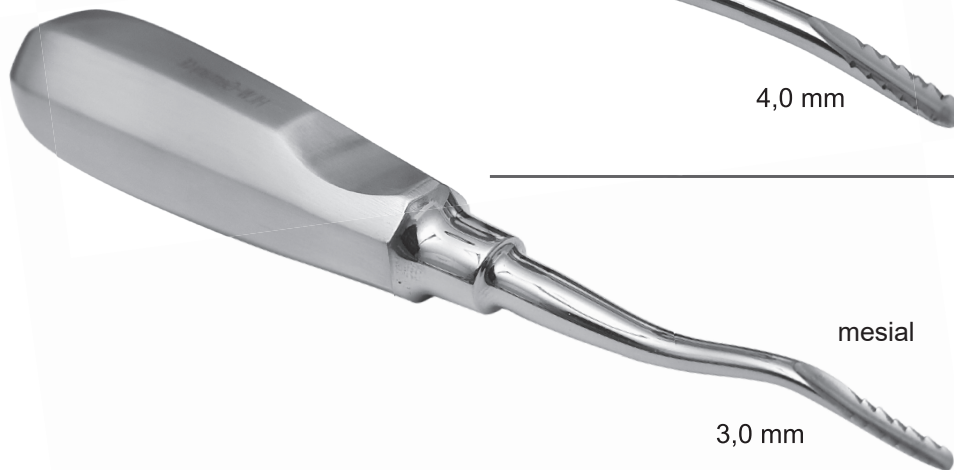

mesial

3,0 mm

Ref. 13-89M





**Silikon-Mundkeile**

Ref. 15-40  
groß



Ref. 15-40A  
klein

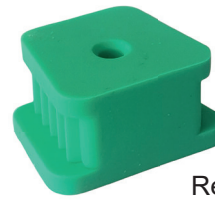

**Mikroschere feine Spitze**

Ref. 19-28A

45° seitlich  
gewinkelt

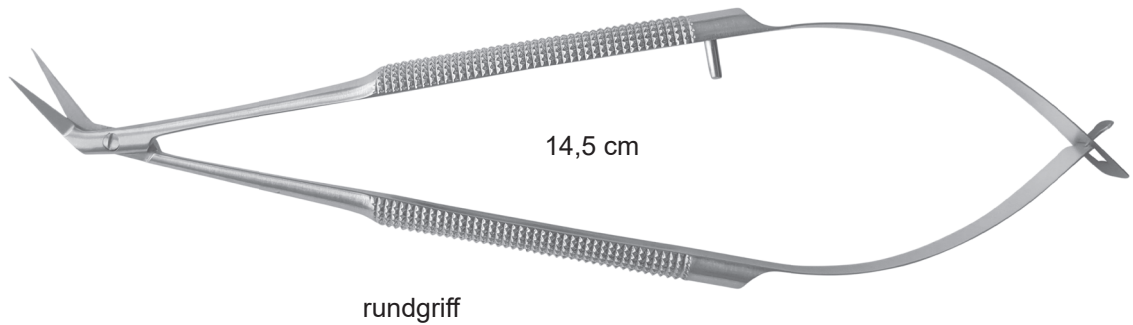

**Bein Heber rechts**

Ref. 13-11BR

3,5 mm

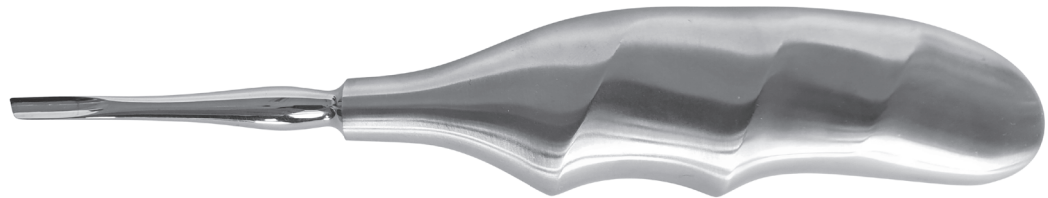

**Bein Heber links**

Ref. 13-11BL

3,5 mm

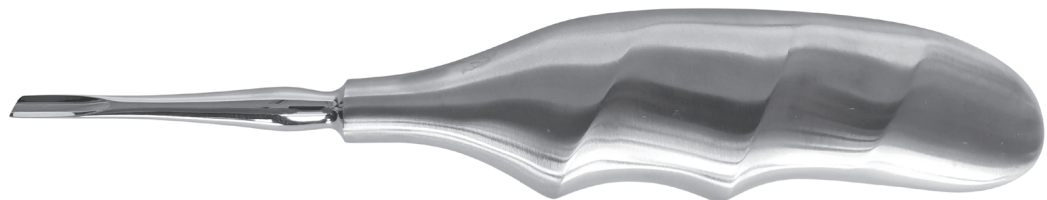

**Hautstanze mit Ergo-Griff**

Ref. 40-53A = 3,0 mm  
Ref. 40-55A = 4,0 mm  
Ref. 40-57A = 5,0 mm





**Medizinschale**



Ø 60 mm  
Ref. 40-51D



Ø 70 mm  
Ref. 40-51E



Ø 80 mm  
Ref. 40-51F



Ø 90 mm  
Ref. 40-51G



32 x 32 mm  
Ref. 40-511



52 x 20 mm  
Ref. 40-512



66 x 32 mm  
Ref. 40-513

**Bohrerstände**



30 Einsätze

Ref. 15-88A

110 x 35 x 35 mm



Ref. 12-107

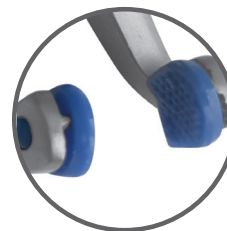

Ref. 12-107A  
Einsätze paarweise

**NEW!**

**Frankfurt Kieferwinkelhaken**

Ref. 15-31A

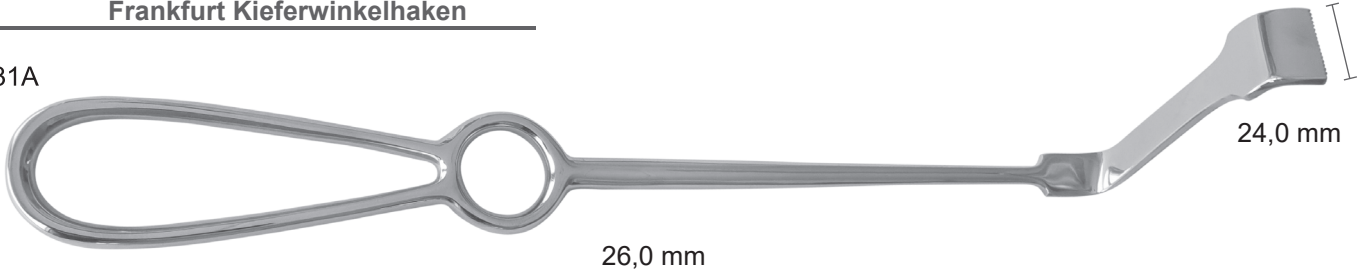

Ref. 15-31B



**Frankfurt Kieferwinkelhaken**

Ref. 15-32A

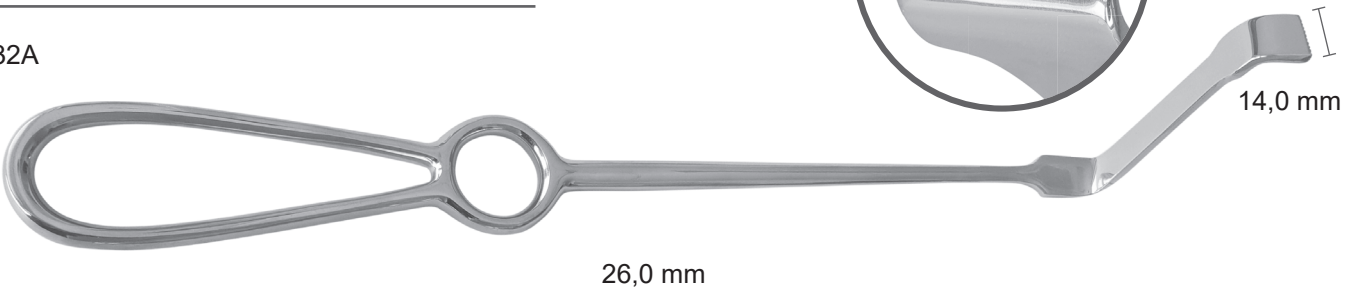

Ref. 15-32B

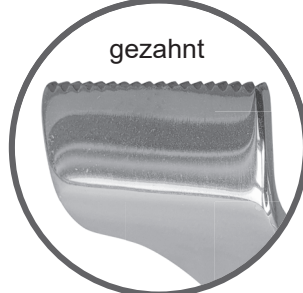

**Obwegeser**

Ref. 15-17E/2

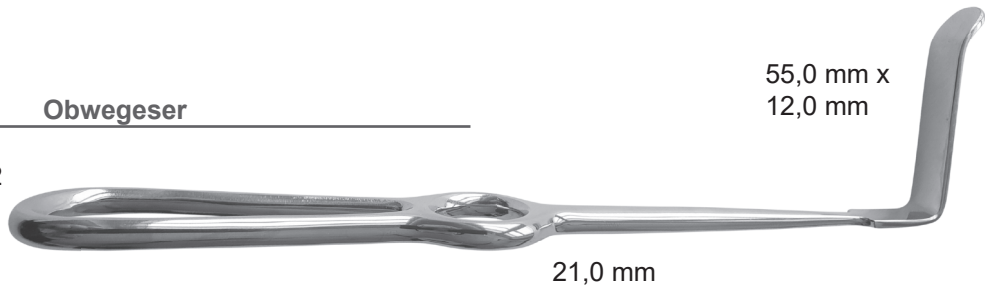

**Wassmund**

Ref. 15-17D

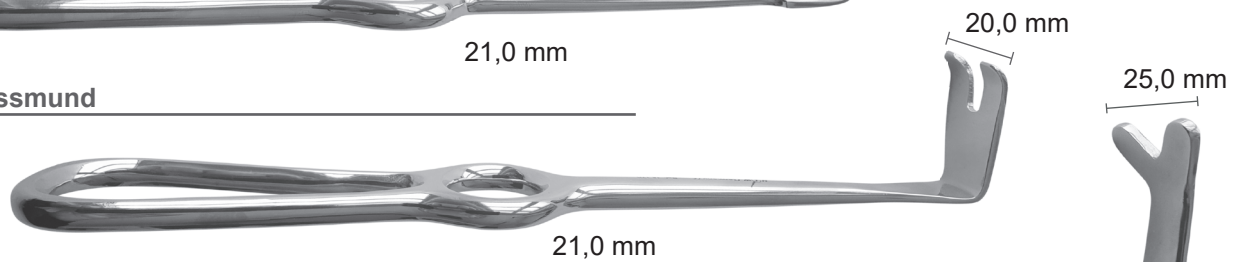

Ref. 15-17F/2

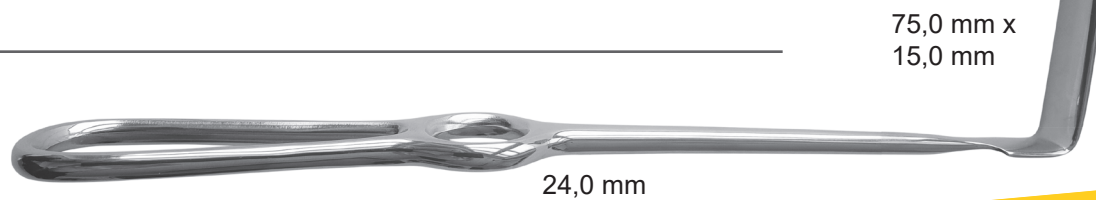

**NEW!**

Oringer

Für handfreies  
Abhalten

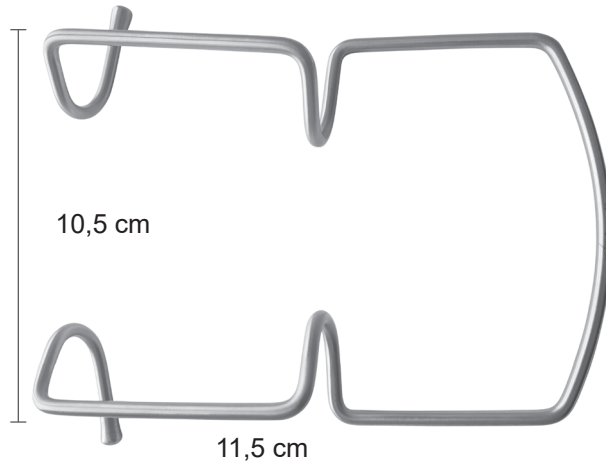

Ref. 40-02C

Lippenhalter Sternberg

30,0 mm

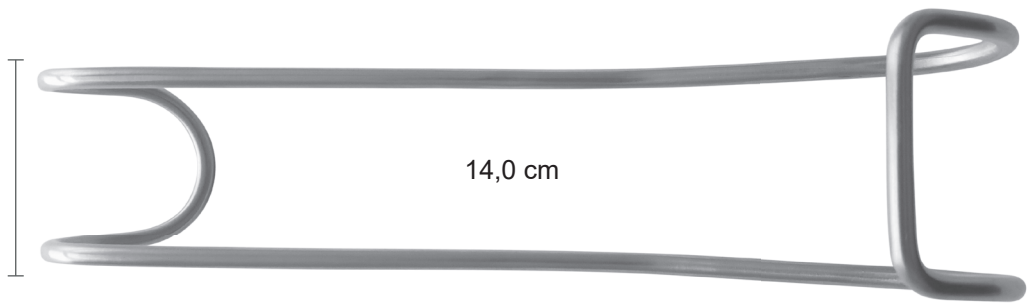

Ref. 40-02B

35,0 mm

14,0 cm

Vestibulum

Ref. 15-1

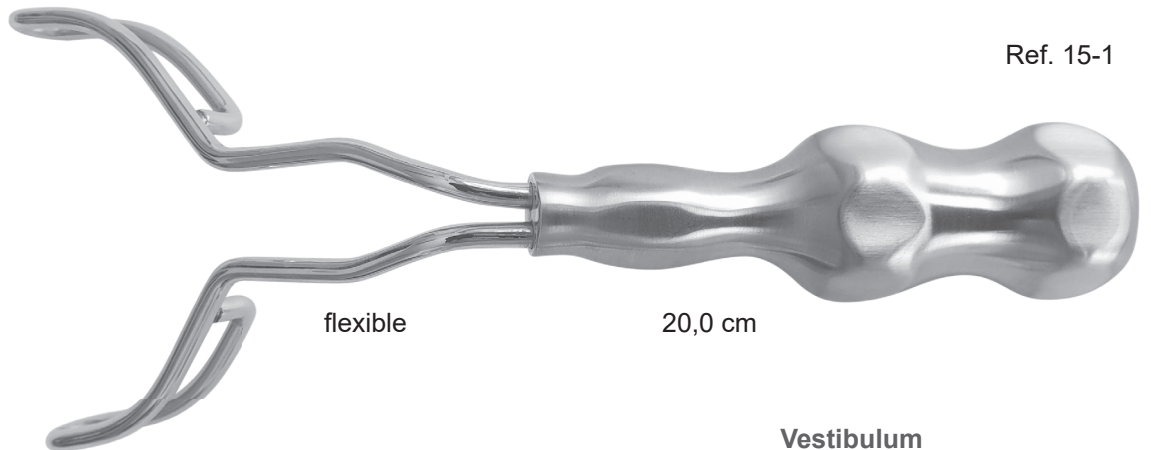

flexible

20,0 cm

Vestibulum

Ref. 15-2

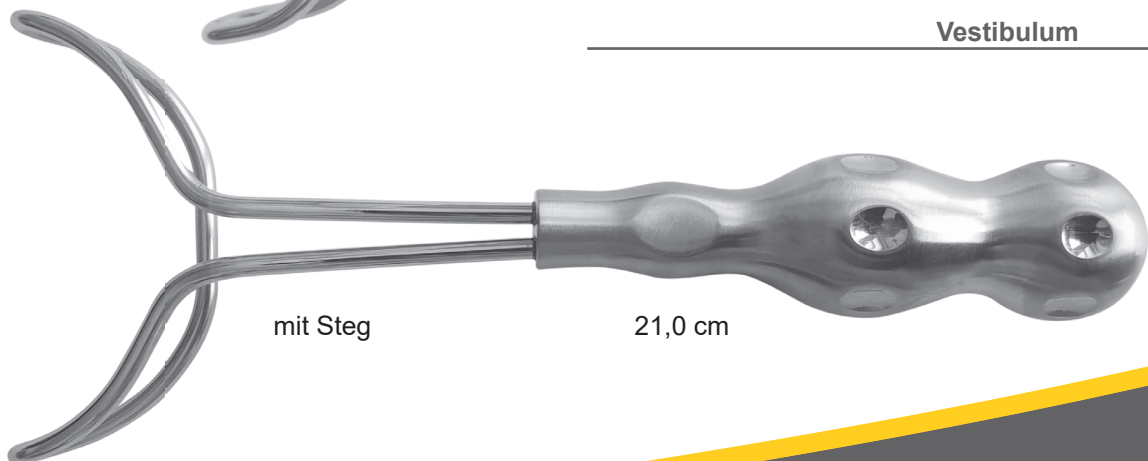

mit Steg

21,0 cm



**NEW!**

nach Bishop

Ref. 15-33

16,0 cm

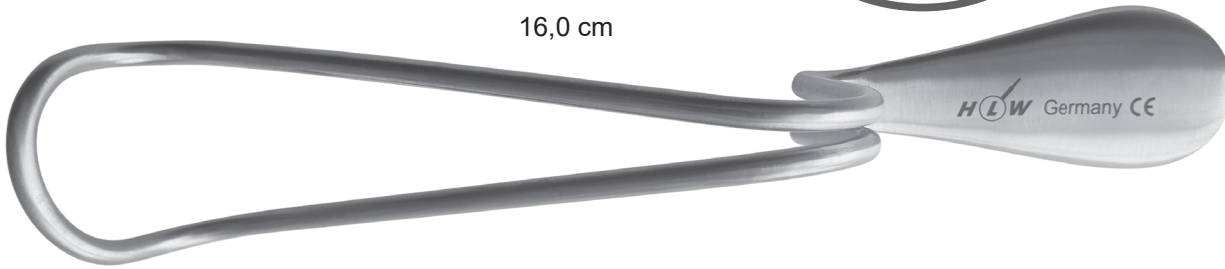

Retractor - weiche Rundung

Ref. 15-34

14,5 cm

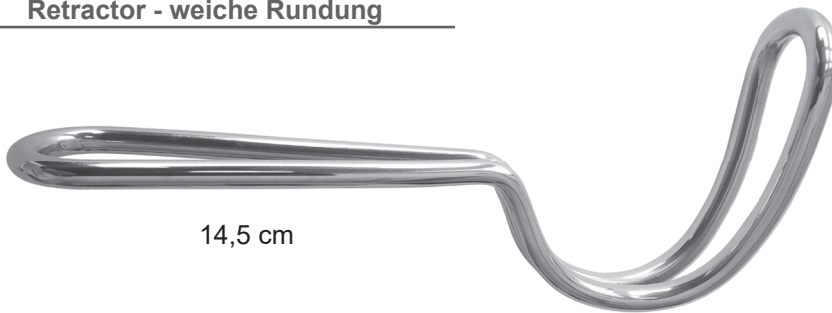

Retractor und Zungenandrücker - nach Wieder

Ref. 15-35

14,0 cm

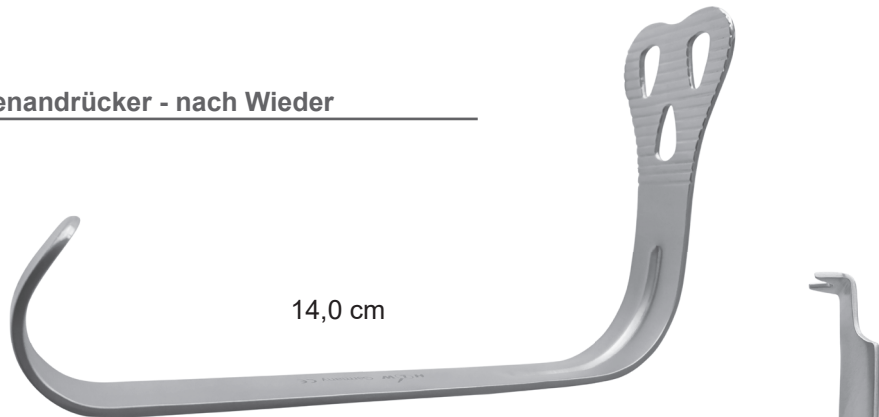

Zungenandrücker - nach Austin

Ref. 15-36

9,0 cm

9,0 cm

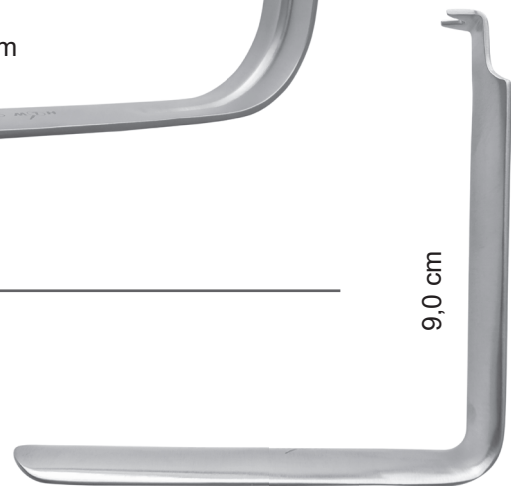

**NEW!**

# Scharfe Löffel

Hohlgriff hollow handle Ø 10,0 mm

Bestell-Nr.  
Order-No.

Ref. 25-1C



Ref. 25-2C

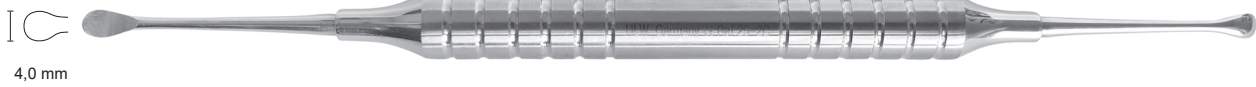

Ref. 25-3C



Ref. 25-4C



Ref. 25-5C

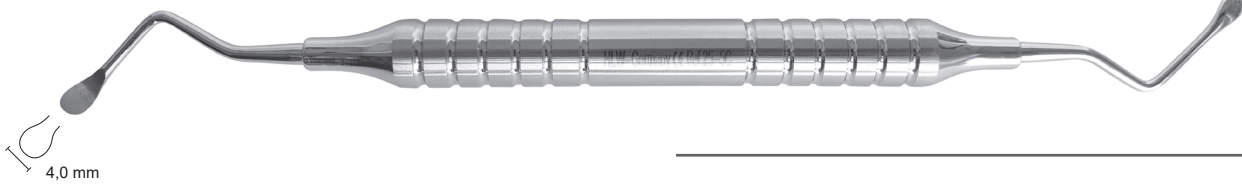

Ref. 25-8C

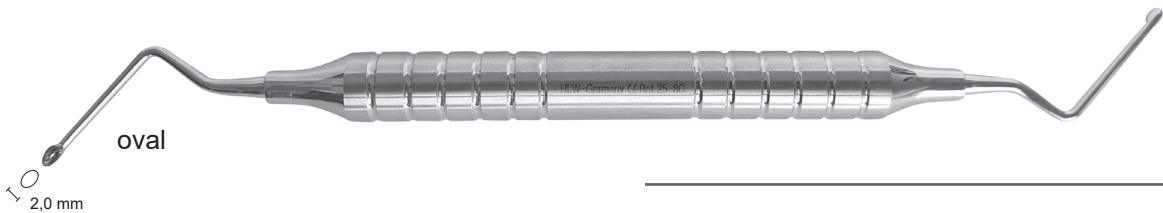

Ref. 25-9C

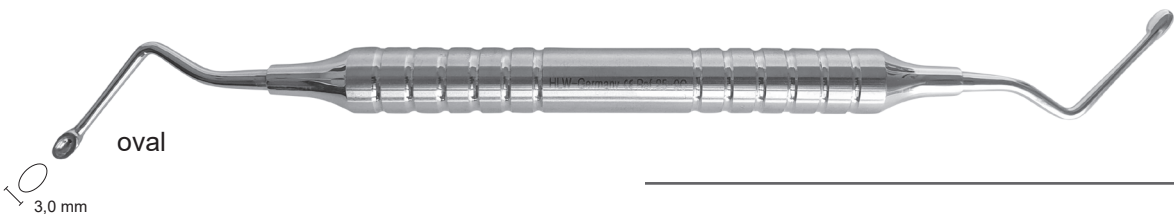

Ref. 25-10C





# Füllungsinstrumente mit Titannitridbeschichtung

**NEW!**

Hohlgriff hollow handle Ø 10,0 mm

Ref. 24-1C

1,5 mm  $\perp$



Ref. 24-2C

2,0 mm  $\perp$



Ref. 24-3C

2,0 mm  $\perp$



Ref. 24-4C

0,9 mm  $\circ$

1,3 mm  $\circ$



Ref. 24-5C

1,3 mm  $\circ$

1,6 mm  $\circ$



Ref. 24-6C

2,4 mm  $\circ$

1,8 mm  $\circ$



Ref. 24-7C

2,0 mm  $\circ$

2,5 mm  $\circ$



Ref. 24-8C

2,0 mm  $\perp$

2,4 mm  $\circ$





**NEW!**



## Küretten & Parodontologie Instrumente

Hohlgriff hollow handle Ø 10,0 mm

Scaler



Jaquette Scaler



Scaler



Scaler



Hohlgriff hollow handle Ø 10,0 mm

## Heidemannspatel

Ref. 29-1C

2,0 mm

flexible

## Heidemannspatel

Ref. 29-2C

2,5 mm

flexible

## Heidemannspatel

Ref. 29-3C

3,0 mm

flexible

Ref. 29-4C

1,5 mm

non flexible

Ref. 29-5C

2,0 mm

non flexible

Ref. 29-11C

2,0 mm

Ref. 29-12C

2,3 mm



**NEW!**

**Kugelstopfer**



Ref. 29-43C

**Kugelstopfer**



Ref. 29-44C

**Kugelstopfer**



Ref. 29-45C

**Kugelstopfer**



Ref. 29-46C

**Diverses**

**Sinuslift Instrument**



**Zementspatel**



Ref. 31-8C

**Zementspatel**



Ref. 31-9C





**TOPSELLER** ✓

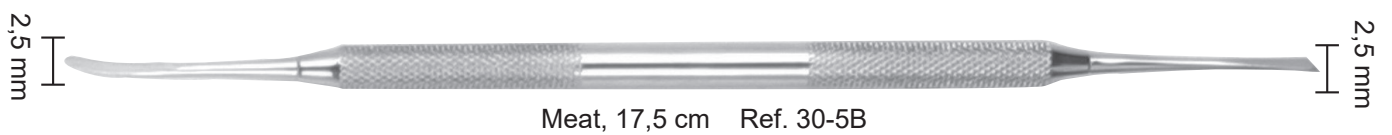
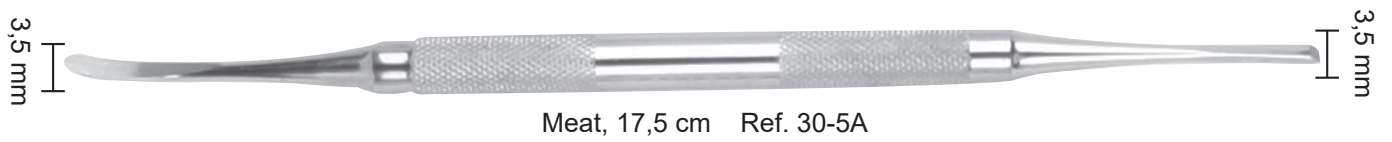
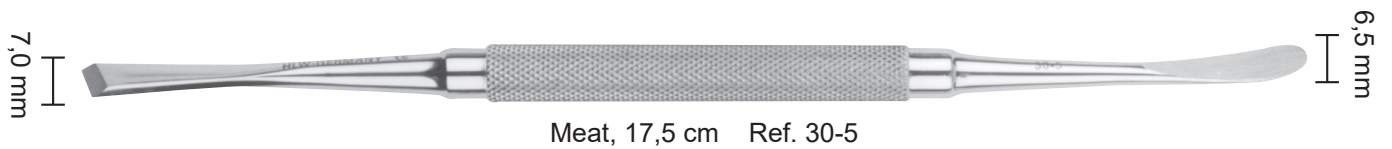
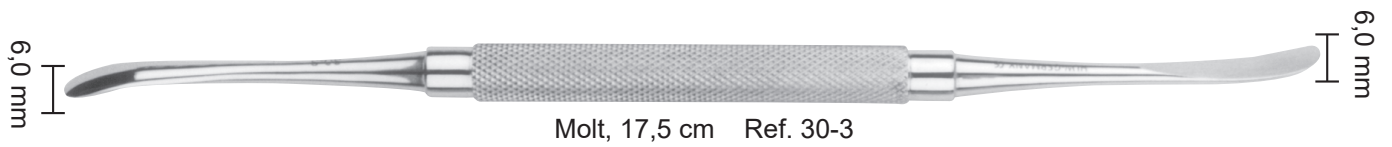
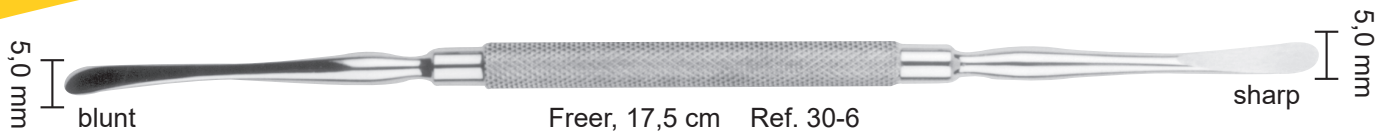

# Zahnzangen Extracting Forceps



OK Schneidezähne  
(Fig. 1)  
Ref. 11-1



OK Prämolaren  
(Fig. 7)  
Ref. 11-7

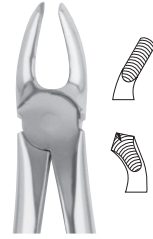

OK Molaren  
(Fig. 17)  
Ref. 11-17

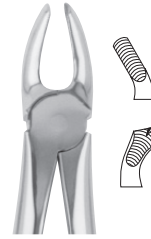

OK Molaren links  
(Fig. 18)  
Ref. 11-18

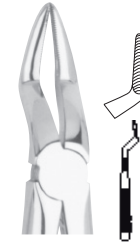

OK Wurzeln  
(Fig. 51A)  
Ref. 11-51A

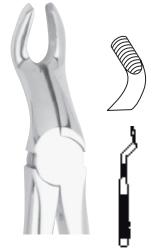

UK Wurzeln  
(Fig. 67A)  
Ref. 11-67A



UK Prämolaren  
(Fig. 13)  
Ref. 11-13



UK Wurzeln  
(Fig. 33)  
Ref. 11-33



UK Molaren  
(Fig. 22)  
Ref. 11-22



UK Molaren  
(Fig. 73)  
Ref. 11-73

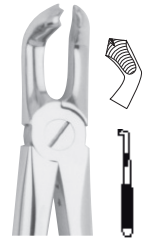

UK dritte Molaren  
(Fig. 79)  
Ref. 11-79

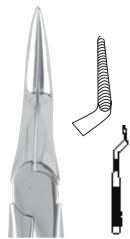

OK Wurzeln  
(Fig. 151)  
Ref. 11-151

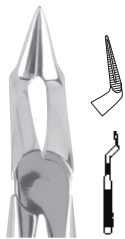

OK Wurzeln  
(Fig. 152)  
Ref. 11-152



UK Wurzeln  
(Fig. 136)  
Ref. 11-136



UK Wurzeln  
(Fig. 145)  
Ref. 11-145



OK Wurzeln  
(Fig. 49)  
Ref. 11-49



UK Wurzeln  
(Fig. 46)  
Ref. 11-46



OK dritte Molaren  
(Fig. 67N)  
Ref. 11-67N

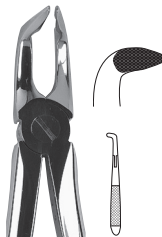

UK dritte Molaren  
(Fig. 79N)  
Ref. 11-79N

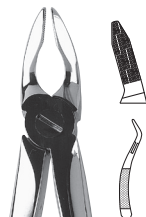

OK Prämolaren  
(Fig. 7N)  
Ref. 11-7N



UK Prämolaren  
(Fig. 36N)  
Ref. 11-36N

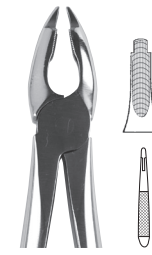

OK Schneidezähne  
(Fig. 34A)  
Ref. 11-34A

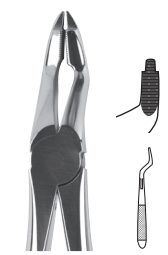

OK Wurzeln  
(Fig. 331)  
Ref. 11-331



OK Prämolaren  
(Fig. 35A)  
Ref. 11-35A



UK Prämolaren  
(Fig. 336)  
Ref. 11-336



UK Prämolaren  
(Fig. 36A)  
Ref. 11-36A

**TOPSELLER** ✓





# Wurzelheber Root Elevators

TOPSELLER



links  
Ref. 13-27S



rechts  
Ref. 13-28S



links  
Ref. 13-302



rechts  
Ref. 13-303

Wurzelheber  
Cryer

Wurzelheber  
Apical



Ref. 13-1 LX gerade

Ref. 13-5 LX gebogen

2,0 mm

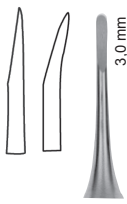

Ref. 13-2 LX gerade

Ref. 13-6 LX gebogen

3,0 mm



Ref. 13-3 LX gerade

Ref. 13-7 LX gebogen

4,0 mm



Ref. 13-4 LX gerade

Ref. 13-8 LX gebogen

5,0 mm



Ref. 13-1B



Ref. 13-2B

3 mm

4 mm



Ref. 13-3B

2 mm



Ref. 13-4B

3 mm



Ref. 13-5B

4 mm



Ref. 13-6B

2 mm



Ref. 13-7B

3 mm



Ref. 13-8B

4 mm

Wurzelheber Bein



Ref. 13-17

2,5 mm



links  
Ref. 13-17L



rechts  
Ref. 13-17R

2,5 mm

Wurzelheber  
Warwick



gerade  
Ref. 13-1MT

2,5 mm



gerade  
Ref. 13-11MT

3,0 mm



gebogen  
Ref. 13-10L MT

3,0 mm



gebogen  
Ref. 13-10R MT

Microtools

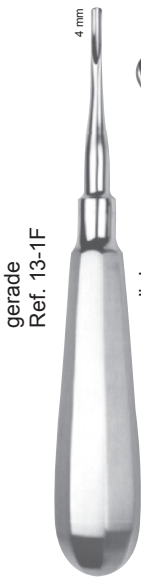

gerade  
Ref. 13-1F

4 mm

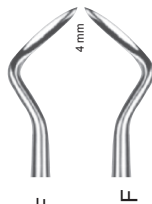

links  
Ref. 13-2F

4 mm



rechts  
Ref. 13-3F

Wurzelheber  
Flohr



gerade  
Ref. 13-4F



links  
Ref. 13-5F



rechts  
Ref. 13-6F

Wurzelheber  
Friedmann



Ref. 13-7HB

2,5 mm



links  
Ref. 13-8HB



rechts  
Ref. 13-9HB

2,5 mm

Wurzelheber  
Heidbrink

**NEW!**

## Raspatoren



Die Lochfunktion ermöglicht das Halten des Gewebes während des Nähvorgangs.

Allen Ref. 30-30C



Raspator

Papillenelevator Pfeilform  
Ref. 40-20A



Prichard Abhalter Ref. 30-20C

## Kronenspreizer



Kronenaufbieger  
Universal

**TOPSELLER** ✓

+

Ref. 30-8B

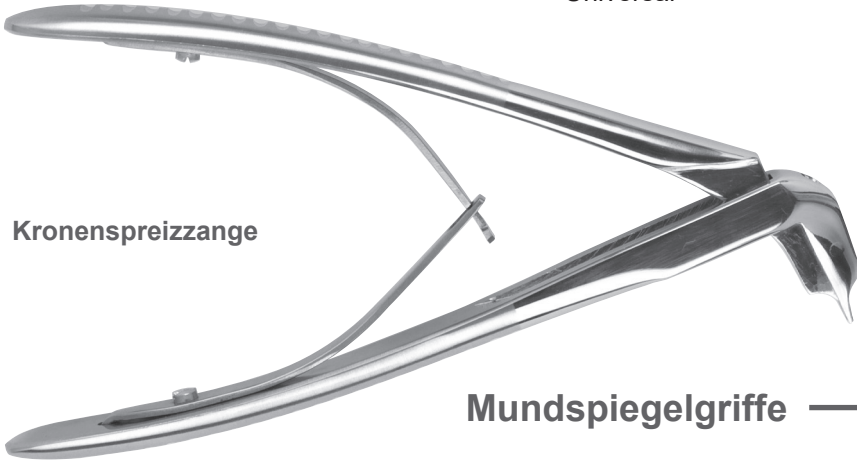

Kronenspreizzange



Ref. 30-8D

## Mundspiegelgriffe

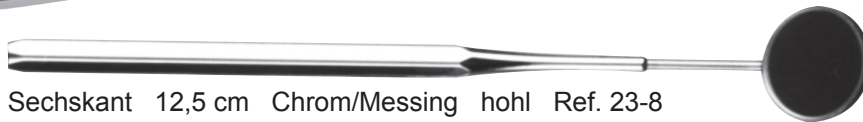

Sechskant 12,5 cm Chrom/Messing hohl Ref. 23-8

**TOPSELLER** ✓

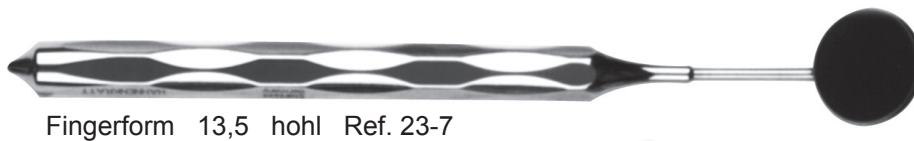

Fingerform 13,5 hohl Ref. 23-7











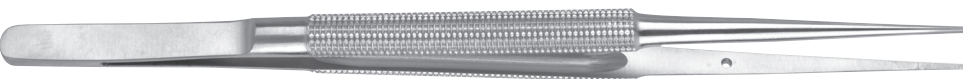

Rundgriff gerändelt 12 cm hohl Ref. 23-10

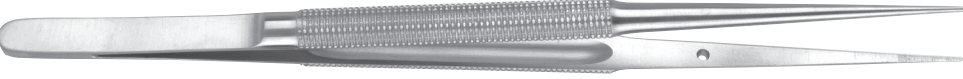

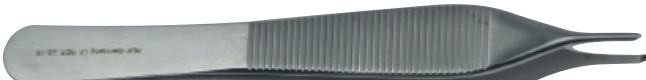



15 cm		<b>Collegepinzette</b>		Ref. 22-3
16 cm		<b>Meriampinzette</b>		Ref. 22-1
18 cm		<b>Micro-Pinzette Gomel</b>	☒ chirurgisch gerade	Ref. 22-30
18 cm		<b>Micro-Pinzette Gomel</b>	☒ chirurgisch gebogen	Ref. 22-31
18 cm		<b>Micro-Pinzette Gomel</b>	anatomisch gerade	Ref. 22-32
18 cm		<b>Micro-Pinzette Gomel</b>	anatomisch gebogen	Ref. 22-33
12 cm		<b>Adson-Pinzette</b>	anatomisch	Ref. 22-14
12 cm		<b>gerade Adson-Pinzette</b>	☒ chirurgisch	Ref. 22-15
12 cm		<b>gebogen Adson-Pinzette</b>	chirurgisch	Ref. 22-16A
12 cm		<b>Micro-Adson-Pinzette</b>	☒ ultra fein	Ref. 22-15A
15 cm		<b>De Bakey</b>	atraumatisch	Ref. 22-35
15 cm		<b>Artikulationspinzette Miller</b>		Ref. 22-23



## Pinzetten



Artikulationspinzette Miller Ref. 22-23A



## Skalpellgriffe

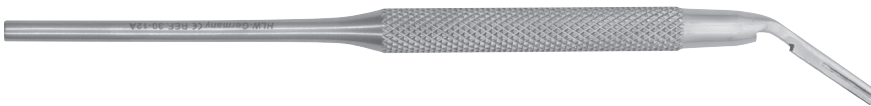

Rundskalpellgriff gebogen  
Ref 30-12A



Rundskalpellgriff-ERGOFORM  
Ref 40-27



Skalpellgriff mit Skalierung  
Ref 30-9A



Skalpellgriff mit Klingenauswurf Funktion  
Ref 30-13

**NEW!**

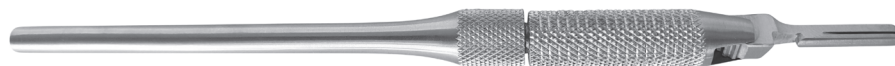

Skalpellgriff mit einstellbarem Winkel  
Ref 30-12B

**NEW!**

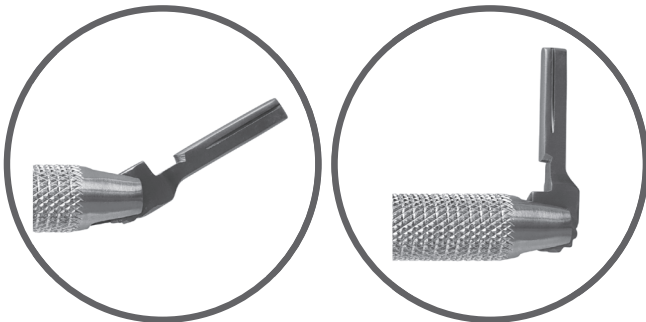



# Nadelhalter - TC

## Needle Holder - TC

TC =Tungsten Carbide

**TOPSELLER**



TOPSELLER



Nadelhalter  
Needle Holder

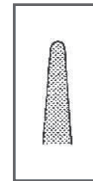
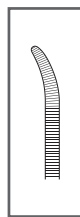
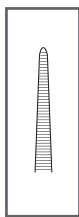

**Halstead-Mosquito**  
gerade 12,5 cm  
Ref. 20-1

**Halstead-Mosquito**  
gebogen 12,5 cm  
Ref. 20-2

**Castroviejo**  
14 cm  
Ref. 20-16

**Mathieu**  
14 cm  
Ref. 20-13

### Wurzelspitzen- und Hohlmeisselzangen



**17,0 cm**  
Ref. 12-108 gezahnt  
Ref. 12-108D diamantiert



**17,0 cm**  
Ref. 12-109 gezahnt  
Ref. 12-109D diamantiert



**Stieglitz**  
13,5 cm  
Ref. 13-60S

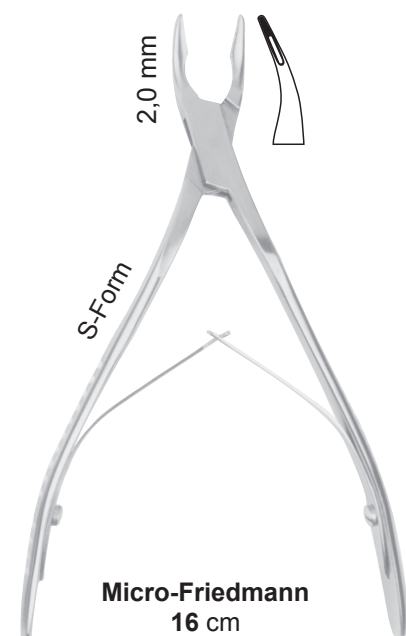

**Micro-Friedmann**  
16 cm  
Ref. 14-2







TC =Tungsten Carbide



**Iris - Schere TC**  
gerade, 11,5 cm  
Ref. 19-1 TC

**Iris - Schere TC**  
gebogen, 11,5 cm  
Ref. 19-2TC



**La Grange Schere TC**  
11,5 cm  
Ref. 19-7 TC

doppelt gebogen



**Goldmann-Fox TC**  
12,5 cm - gezahnt  
Ref. 19-6 TC

gebogen



**Metzenbaum - Schere TC**  
gebogen, 14,5 cm  
Ref. 19-26 TC

feine Spitze

gebogen

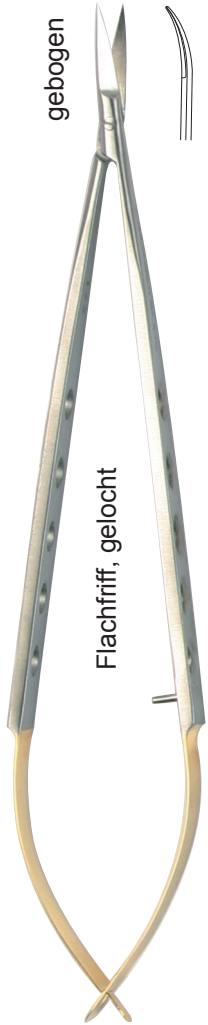

gebogen

Flachgriff, gelocht

**Micro Schere TC**  
17 cm  
Ref. 19-23 B



gebogen

Rundgriff, glatt

**Micro Schere TC**  
17 cm  
Ref. 40-48 B



gebogen

Flachgriff, gerieft

**Castroviejo TC**  
14 cm Ref. 19-23 TC  
17 cm Ref. 19-23A TC



gebogen

Rundgriff mit Profil

**Castroviejo-Gomel TC**  
14 cm  
Ref. 19-28 TC

TOPSELLER



Scheren  
Scissors

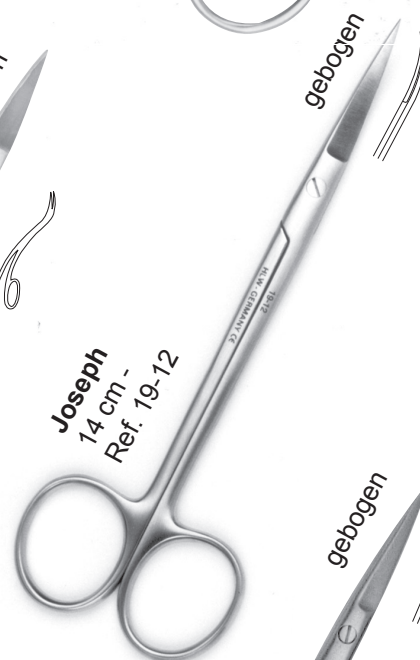
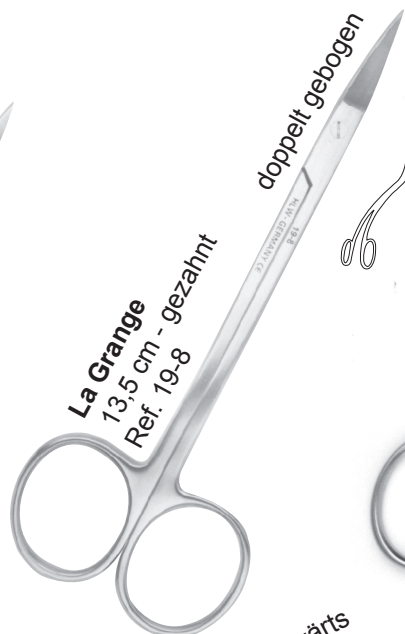
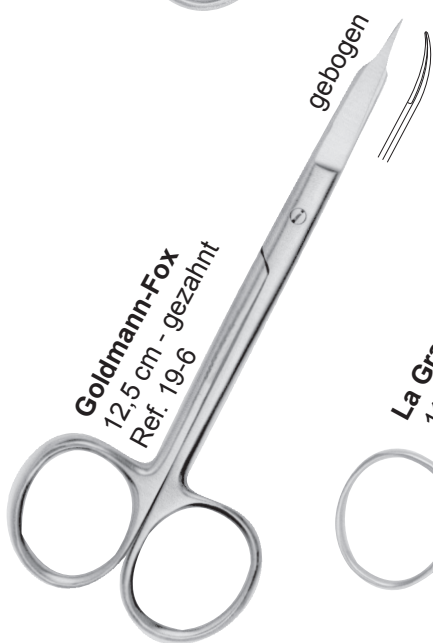
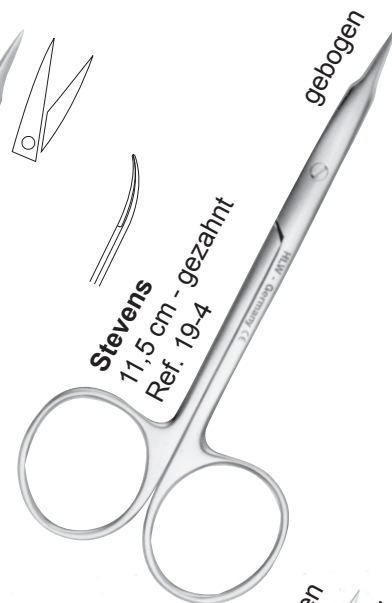
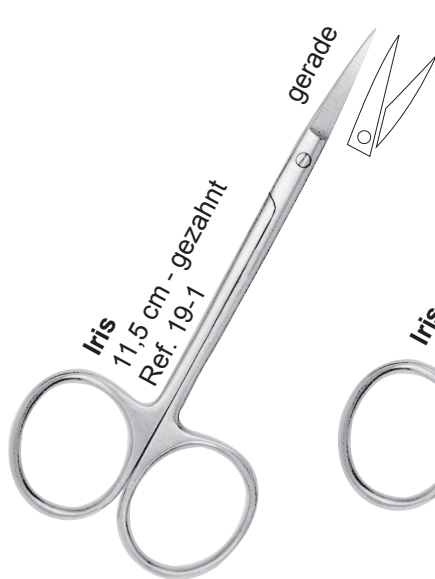

Die HLW SUPER-CUT Scheren zeichnen sich an einer Seite der Schneide, durch einen Spezialschliff und an der gegenüberliegenden Schneide, durch eine Micro-Zahnung aus.

The HLW SUPER-CUT Scissors has two different cutting blades - one with razor sharp edge and the other with micro-serrations.



gebogen



**Iris**  
11,5 cm

**Ref. 19-2 SC**



doppelt gebogen



**La Grange**  
12 cm

**Ref. 19-7 SC**



gebogen

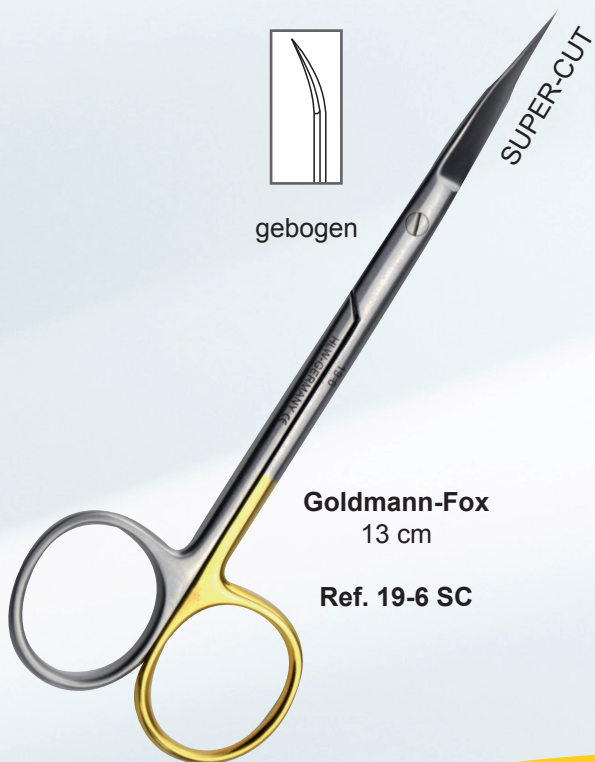

**Goldmann-Fox**  
13 cm

**Ref. 19-6 SC**



gebogen



**Kelly**  
16 cm

**Ref. 19-15 SC**